

СОЕДИНИТЕЛИ СЕРИИ μ ТСА

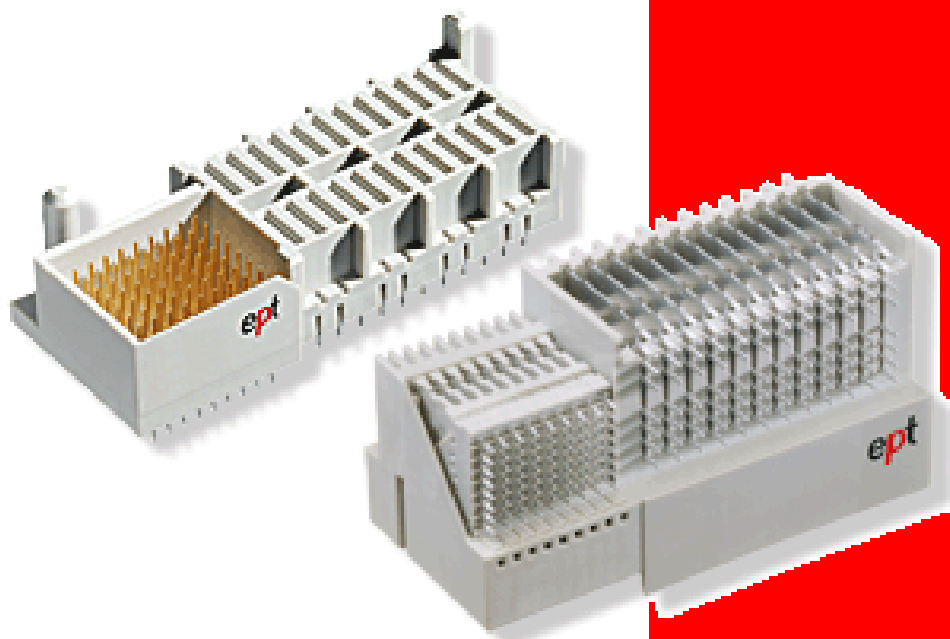

Производство компании ЕРТ

Занько Д.В.

РСР

17.07.2014

Technical specifications AdvancedTCA® and MicroTCA® signal connector

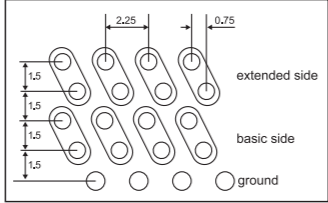
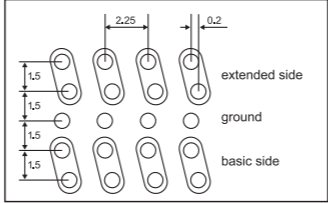
System	AdvancedTCA®	MicroTCA®
Type	AMC B+ signal connector CardEdge	AMC signal connector CardEdge
Specification	PICMG® AMC.0	PICMG® MTCA.0 R1.0
No. of contacts	170	170
Contact spacing	0.75 mm	0.75 mm
Clearance and creepage distance between the contacts	min. 0.1 mm	min. 0.1 mm
Operational current of 8 power contacts according to specification	1.52 A @ 70 °C max. 30 °C temperature rise	1.52 A @ 70 °C max. 30 °C temperature rise
Operating temperature range	- 55 °C to + 105 °C	- 55 °C to + 105 °C
Test voltage	80 V _{r.m.s}	80 V _{r.m.s}
Contact resistance	max. 60 mΩ (ground contacts) max. 90 mΩ (signal, power, general purpose contacts)	max. 25 mΩ
Insulation resistance	10 ⁸ Ω	10 ⁸ Ω
Mating cycles	200	200
Termination technology	Compliant Pin	Compliant Pin
Engaging force	max. 100 N	max. 100 N
Separating force	max. 65 N	max. 65 N
Impedance (nominal differential)	100 Ω ± 10 %	100 Ω ± 10 %
Cross talk (NEXT - pair to pair) @ 30 ps rise time	basic to basic < 0.6 % basic to extended < 0.9 % extended to extended < 0.6 % diagonal < 0.3 % multiline < 3.0 %	basic to basic < 0.5 % basic to extended < 0.2 % diagonal < 0.1 % multiline < 2.0 %
		
Differential signal propagation time	Basic side: 125 ps Extended side: 145 ps	Basic side: 75 ps Extended side: 75 ps
Differential signal propagation difference	Between basic and extended side: 20 ps Within basic and extended side: ± 2 ps	Between basic and extended side: ± 2 ps Within basic and extended side: ± 2 ps
Insulator material	LCP, UL 94-V0	LCP, UL 94-V0
Contact material	Copper alloy	Copper alloy
Contact surface	Pd/Ni	Pd/Ni
Environment/approvals	RoHS compliant/UL (file: E130314)	RoHS compliant/UL (file: E130314)

Technical specifications AdvancedTCA® and MicroTCA® power connector

System	AdvancedTCA®	MicroTCA®
Type	Power connector Female and male connector	Power connector Backplane and power module output
Specification	PICMG® 3.0 R2.0	PICMG® MTCA.0 R1.0
No. of contacts	30	96
Power contacts	8	24
Signal contacts	22	72
Operational current	Power contacts: max. 16 A Signal contacts: max. 1 A	Power contacts: max. 12 A Signal contacts: max. 1 A
Operating temperature range	- 55 °C to + 125 °C	- 55 °C to + 105 °C
Test voltage	Contact 1 – 16 1000 V _{r.m.s} Contact 17 – 34 2000 V _{r.m.s}	80 V _{r.m.s}
Contact resistance	Power contacts: ≤ 2,2 mΩ Signal contacts: ≤ 8,5 mΩ	Power contacts: ≤ 5 mΩ Signal contacts: ≤ 25 mΩ
Insulation resistance	≥ 10 ¹⁰ Ω	≥ 10 ⁸ Ω
Mating cycles	250	200
Termination technology	Compliant Pin	Compliant Pin
Engaging force	max. 67 N	max. 50 N
Separating force	max. 67 N	max. 50 N
Insulator material	PBT glass filled, UL 94 V-0	PBT glass filled, UL 94 V-0
Contact material	Copper alloy	Copper alloy
Contact surface	Au	Power: Au Signal: Pd/Ni
Environment/approvals	RoHS compliant/UL (file: E130314)	RoHS compliant/UL (file: E130314)

Derating diagrams

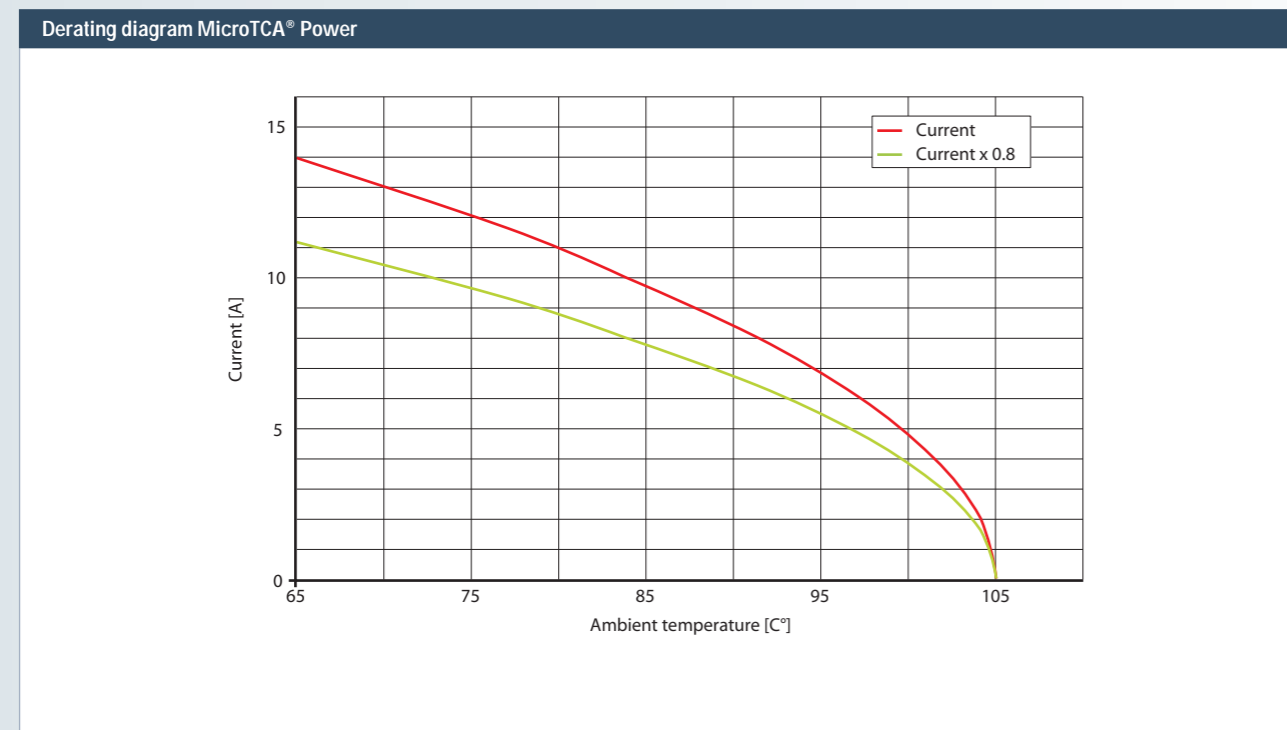
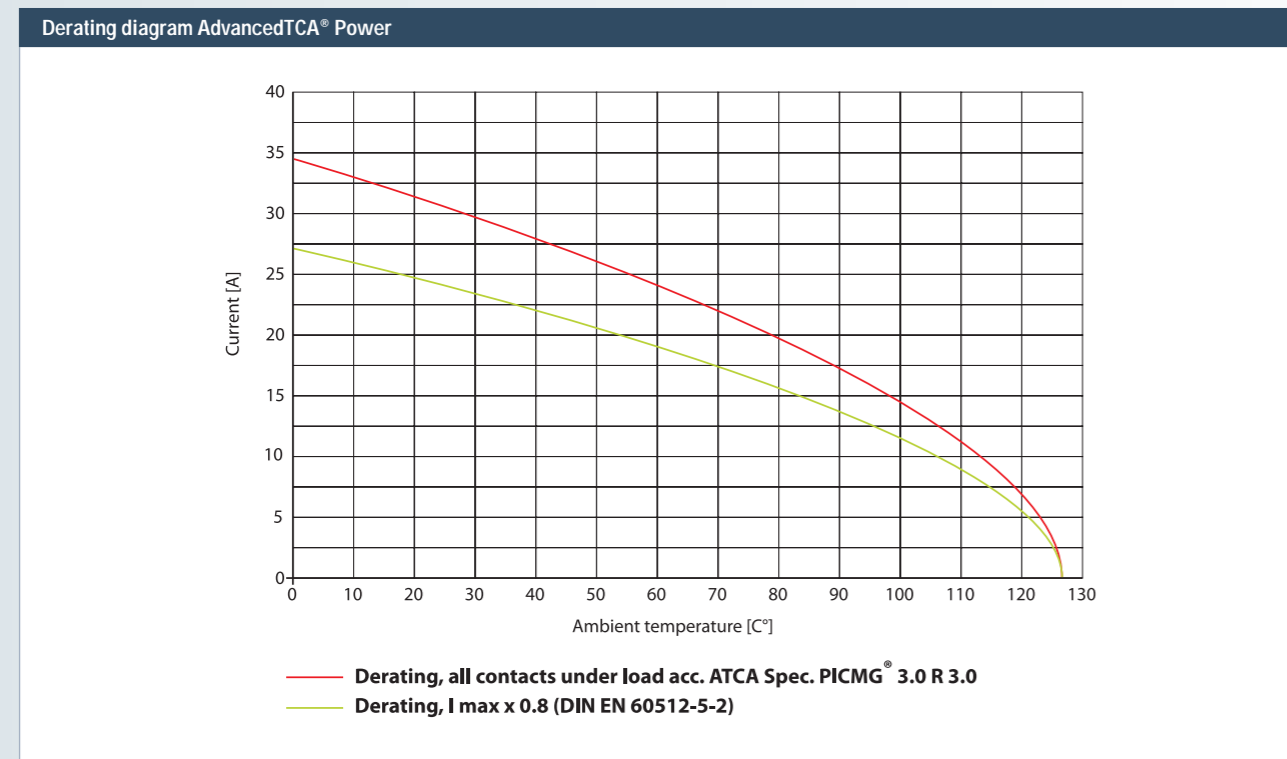

AMC signal connector for AdvancedTCA® and MicroTCA®

Plated through-hole according to IEC 60352-5

	Nominal hole	Ø 0.55 mm
imm. Sn printed circuit boards		
A	PCB thickness	min. 1.4 mm
B	Plated hole	Ø 0.55 ± 0.05 mm
C	Drill hole	Ø 0.64 ± 0.01 mm
D	Cu plating	min. 25 µm
E	Imm. Sn plating	max. 1.5 µm
F	Annular ring	min. 0.15 mm
Ni, Au printed circuit boards		
A	PCB thickness	min. 1.4 mm
B	Plated hole	Ø 0.55 ± 0.05 mm
C	Drill hole	Ø 0.64 ± 0.01 mm
D	Cu plating	min. 25 µm
E	Ni, Au plating	0.05 – 0.2 µm Au over 2.5 – 5 µm Ni
F	Annular ring	min. 0.15 mm

AdvancedTCA® power male connector

Plated through-hole according to IEC 60352-5

	Nominal hole	Ø 1.0 mm	Ø 1.6 mm
imm. Sn printed circuit boards			
A	PCB thickness	min. 1.4 mm	min. 1.4 mm
B	Plated hole	Ø 1 + 0.09/-0.06 mm	Ø 1.6 + 0.09/-0.06 mm
C	Drill hole	Ø 1.15 ± 0.025 mm	Ø 1.75 ± 0.025 mm
D	Cu plating	min. 25 µm	min. 25 µm
E	Imm. Sn plating	max. 1.5 µm	max. 1.5 µm
F	Annular ring	min. 0.1 mm	min. 0.1 mm
Ni, Au printed circuit boards			
A	PCB thickness	min. 1.4 mm	min. 1.4 mm
B	Plated hole	Ø 1 + 0.09 mm/-0.06 mm	Ø 1.6 + 0.09 mm/-0.06 mm
C	Drill hole	Ø 1.15 ± 0.025 mm	Ø 1.75 ± 0.025 mm
D	Cu plating	min. 25 µm	min. 25 µm
E	Ni, Au plating	0.05 – 0.2 µm Au over 2.5 – 5 µm Ni	0.05 – 0.2 µm Au over 2.5 – 5 µm Ni
F	Annular ring	min. 0.1 mm	min. 0.1 mm

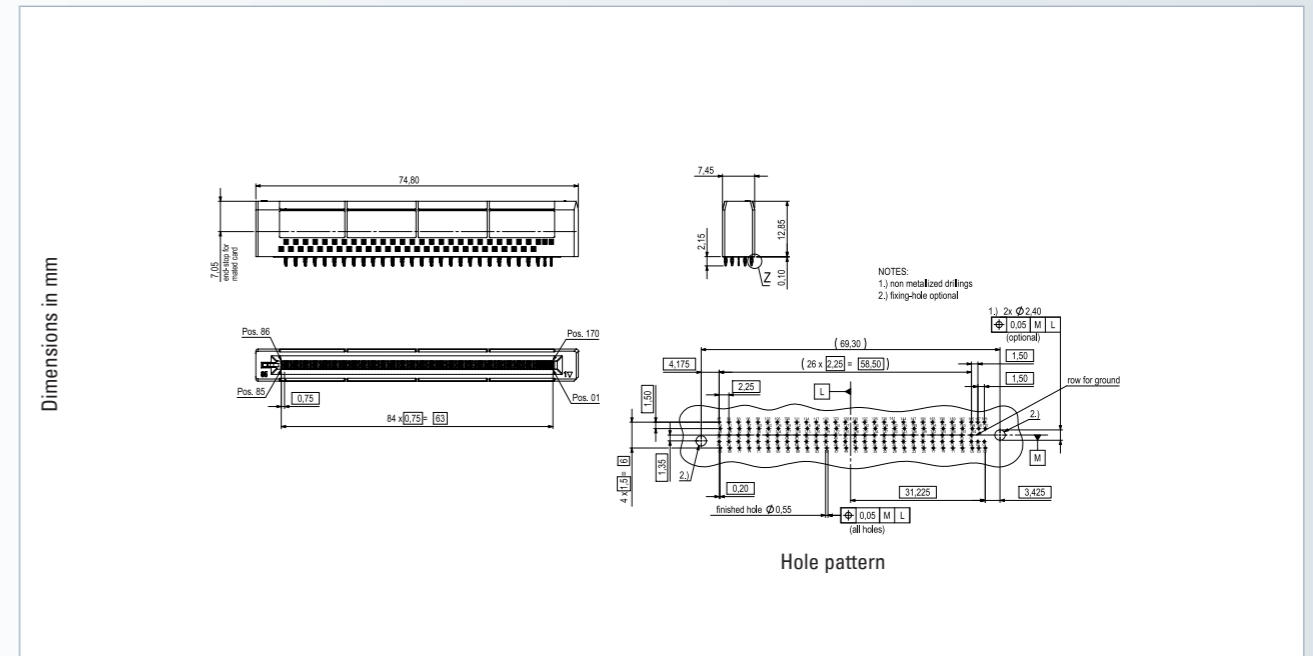

No. of contacts	Press-fit technology	
	without Peg	with Peg
170	502-14170-153	502-14170-153PG1

Accessories
– Press-fit tool (see page 196)
– Support tool (see page 197)

Cross Reference
– Function GuideSpring/**con:card+**[®] (see page 13)

Note
– Peg means alignment pins during mounting to the backplane.



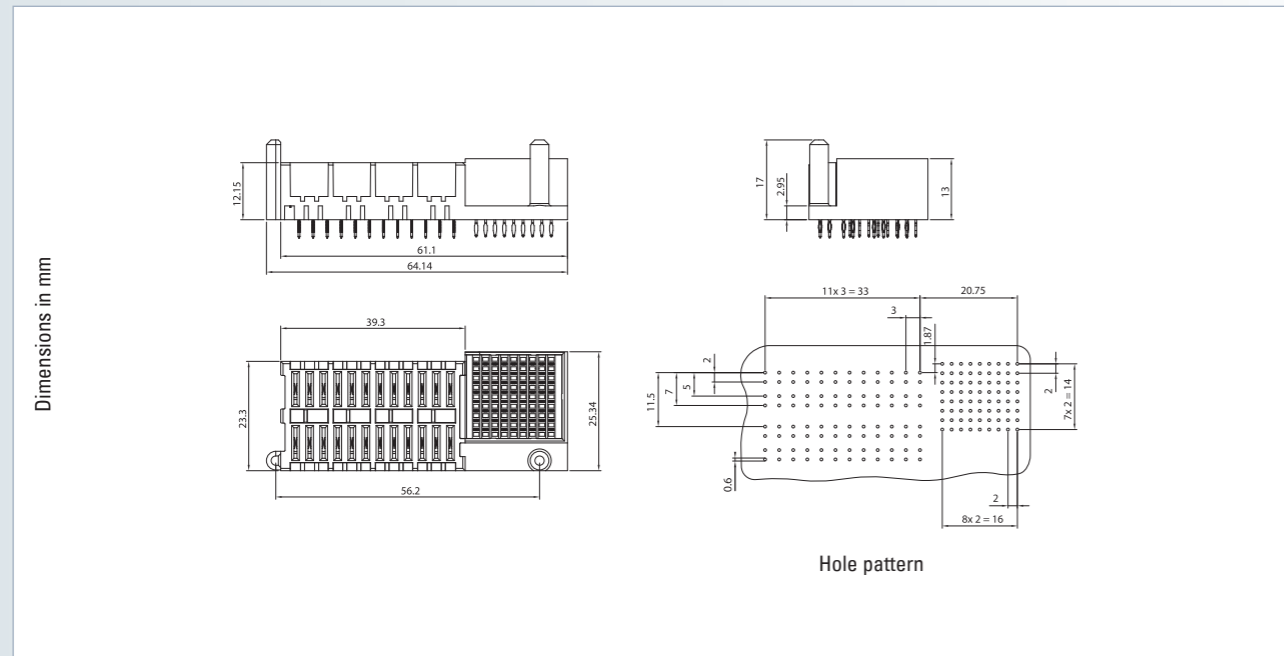

No. of contacts	Press-fit technology
	Part number
72 Signal 24 Power	502-50096-183

Accessories
– Press-fit tool (see page 196)
– Support tool (see page 197)

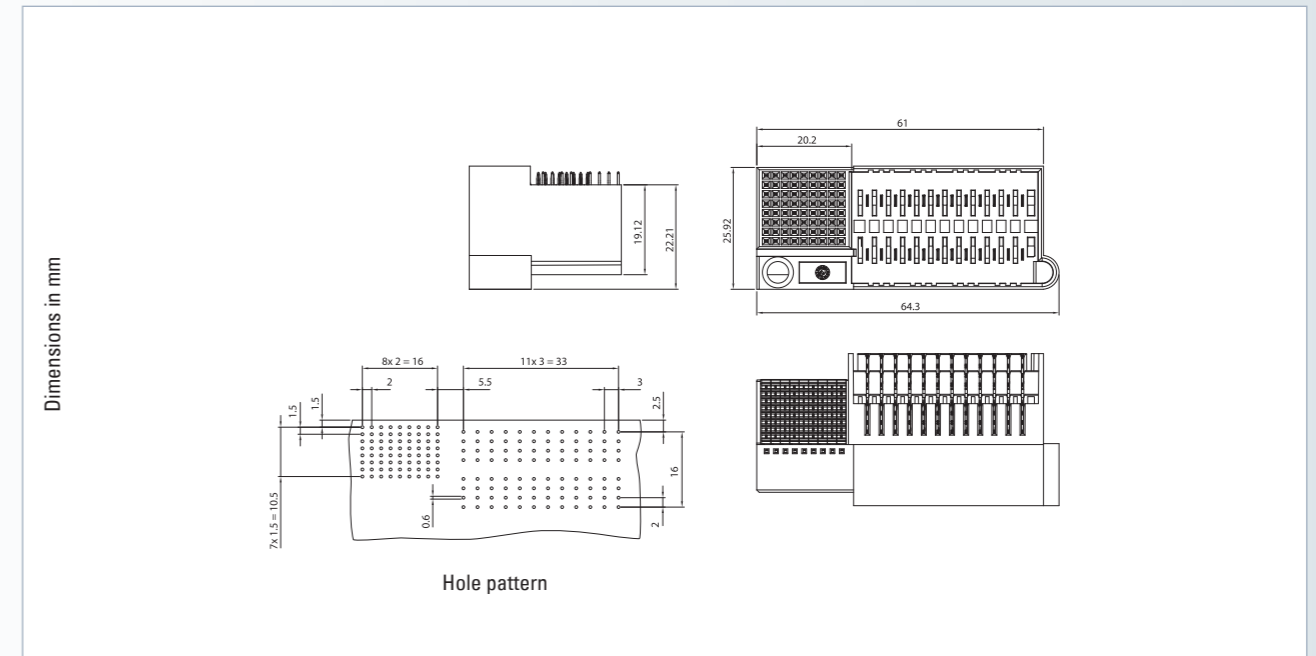
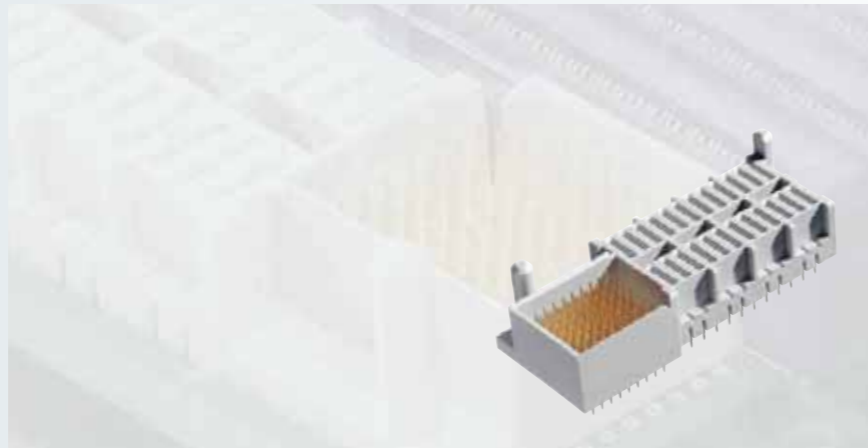

No. of contacts	Press-fit technology
	Part number
72 Signal 24 Power	501-50096-183

Accessories
– Press-fit tool (see page 196)
– Support tool (see page 197)





Компания РСП - официальный дистрибьютор ЕРТ на территории СНГ

Москва	Санкт-Петербург	Челябинск	Екатеринбург	Зеленоград
+7 (495)781-21-82 +7 (495)780-36-86	+7 (812) 490-02-00 +7 (812) 404-65-32	+7 (351) 267-23-28 +7 (351) 239-80-08	+7 (343) 220-37-81 +7 (343) 220-37-82	+7 (495) 981-94-86

Производство ерт в Германии

ept GmbH
Bergwerkstr. 50
86971 Peiting, Germany
Tel. +49 (0) 88 61 / 25 01 0
Fax +49 (0) 88 61 / 55 07
sales@ept.de

Производство ерт в США

ept, inc.
805 Liberty Way
Chester, Virginia 23836, USA
Tel. +1 804 530 0820
800 323 2568
Fax +1 804 530 0837
sales@eptusa.com

Производство ерт в Китае

ept Electronic Precision Technology (Shanghai) Ltd.
6F Building 37,
No. 333 Qin Jiang Road
Shanghai, P. R. China
Post code: 20 02 33
Tel. +86 (0) 21-54 26-09 88
Fax +86 (0) 21-64 95-39 49
sales@eptcn.com